

CreoKit
cut join build

NÁVOD

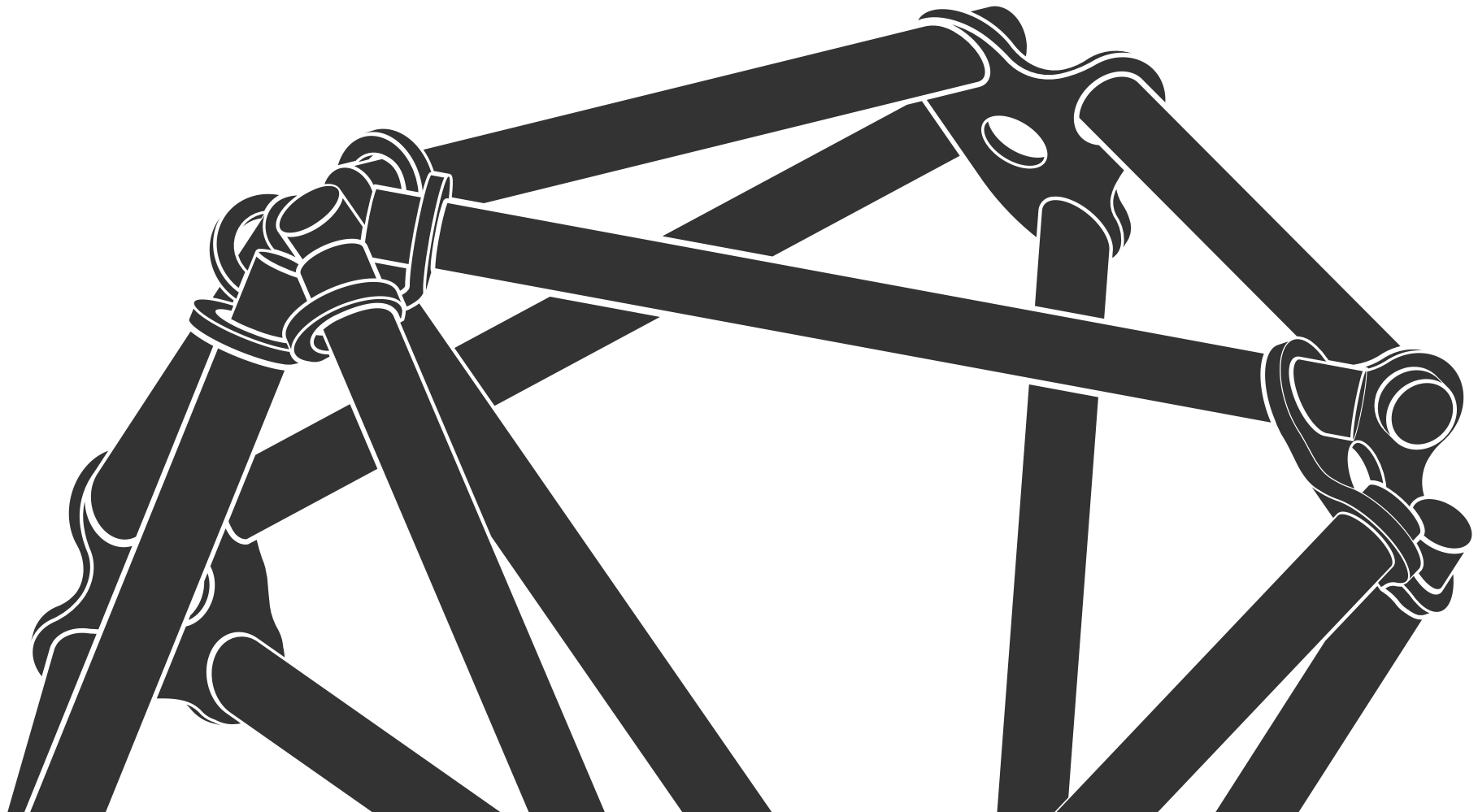

CreoKit je kreativní dřevěná stavebnice, která využívá jako hlavní stavební prvek dřevěné tyče ze smrkového dřeva a spojky ze silikonové pryže. Mimo ně jsou ve stavebnici i další spojky jako magnetické s ocelovou kuličkou a provázky. Kompletní sada je včetně děliče dřevěných tyčí. Ten je navržen tak, aby umožňoval jednoduše a hlavně bezpečně krátit tyče na potřebnou délku.

Cílem je z obsahu krabice sestavit různé konstrukce, ať už podle vzoru, nebo dle vlastní fantazie. V návodu je ukázáno několik druhů spojení s využitím různých spojek a ukázka několika vzorových staveb.

Hlavní myšlenkou stavebnice je motivovat fantazii dítěte při jeho navrhování a sestavování vlastních modelů.

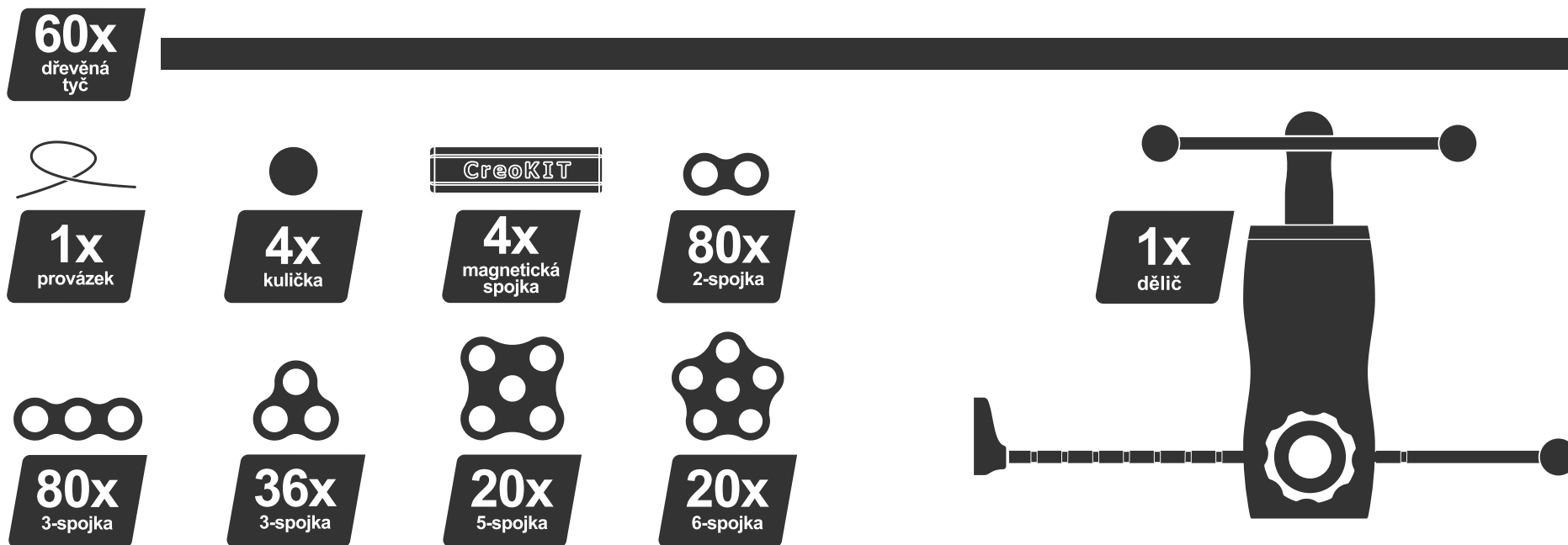

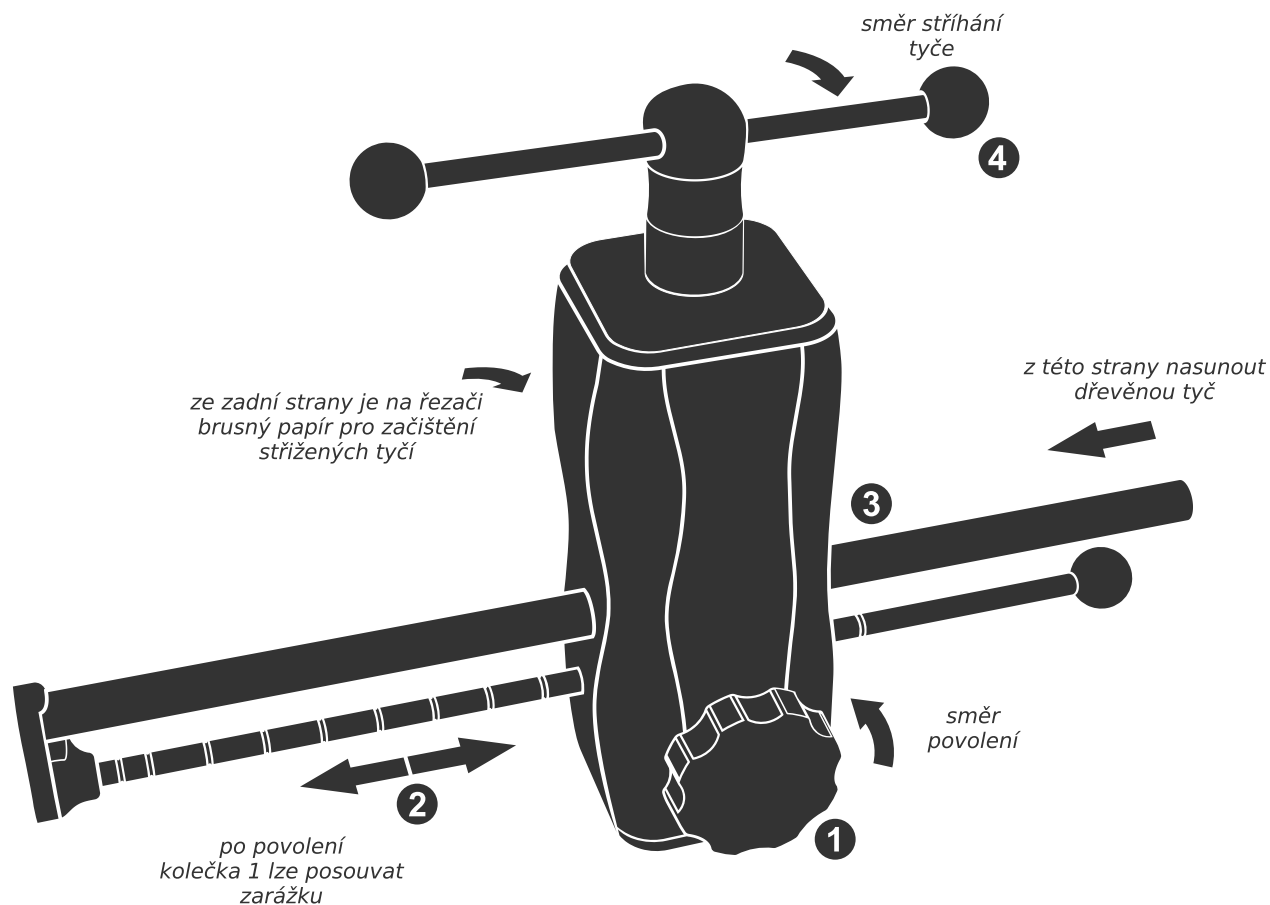

Ke stavbě modelů lze využít kulatinu buď v dodané délce, anebo si ji dle potřeby nakrátit přiloženým ručním děličem. Funkce je jednoduchá: povolením **kolečka 1** se uvolní **zarážka 2**, která se nastaví na potřebnou délku kulatiny (**1 dílek = 1cm**) a zpětným utažením **kolečka 1** se zajistí. Kulatina se vloží do **otvoru 3**, zasune se po zahnutí zarážky, a otáčením **kličky 4** dojde k jejímu ustřížení. Poté se opačným otáčením **kličky 4** nůž vysune zpět, kulatina se vyjme a lze řezat další kus.



2-SPOJKA
dokáže spojit dvě tyče pod
různým úhlem, nebo několik
tyčí do pružného řetězu



SPOJENÍ PROVÁZKEM
využijeme tam, kde chceme,
aby se část sestavy volně
houpala

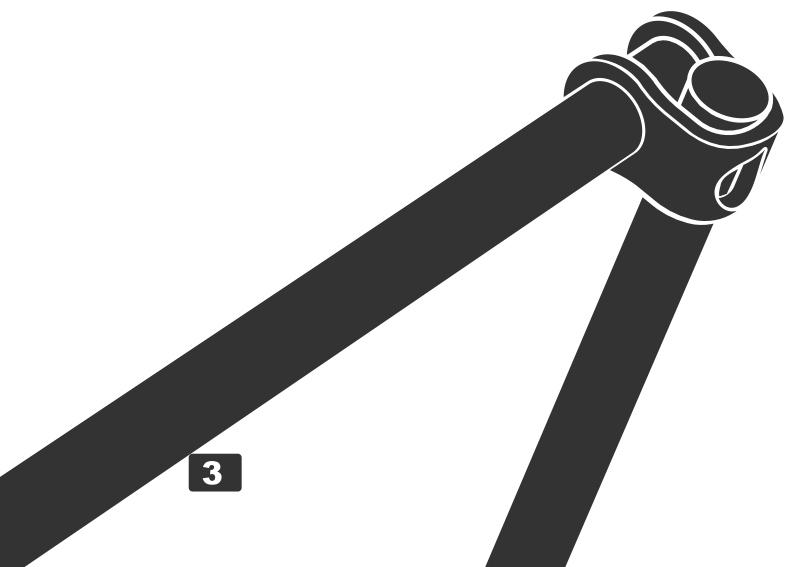

3-SPOJKA ŘADOVÁ
spojí 2 tyče pevně k sobě
s libovolným náklonem, nebo
dokáže spojit tyče do tvaru T

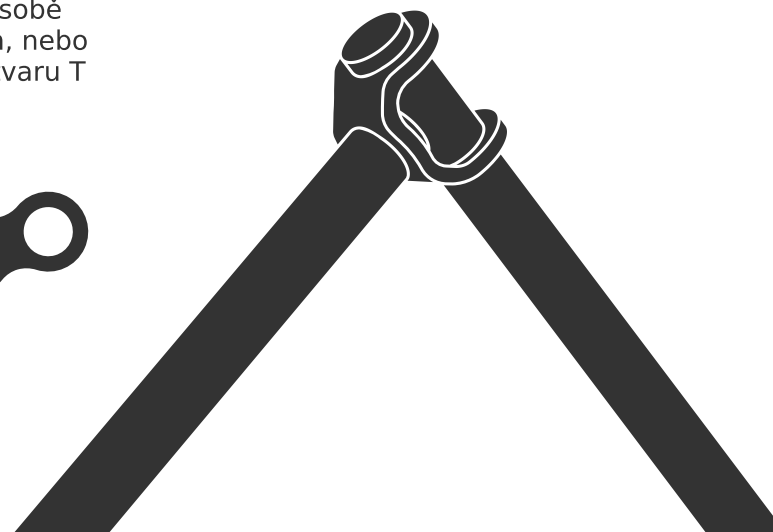



SPOJKA MAGNETY S KULIČKOU

dokáže otočně spojit dvě části
staveb v jednom bodě

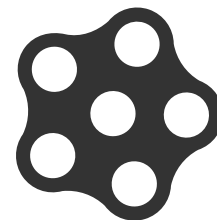
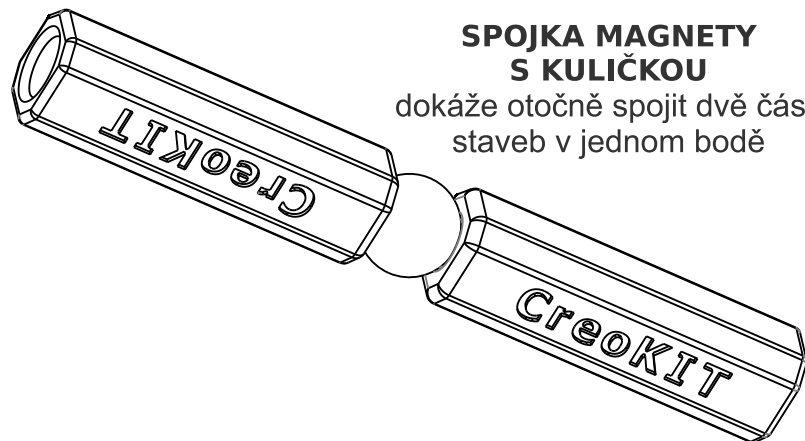

6-SPOJKA

spojí až šest tyčí ve vrcholu,
nebo pět po obvodu s jednou
prostřední průchozí



5-SPOJKA

spojí až pět tyčí ve vrcholu,
nebo čtyři po obvodu s jednou
prostřední průchozí

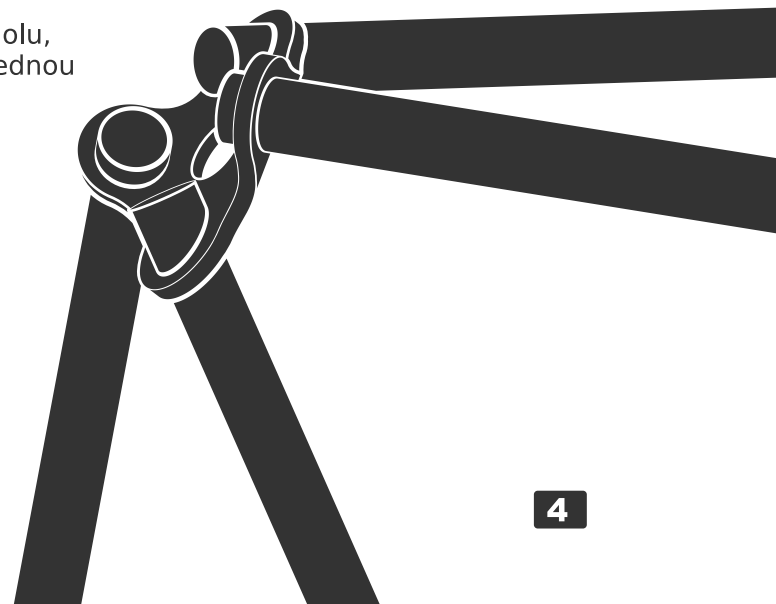
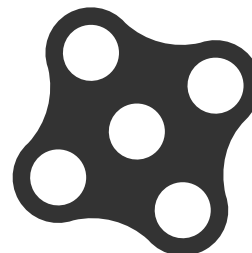

3-SPOJKA KRUHOVÁ

spojí až tři tyče a to
v libovolných úhlech



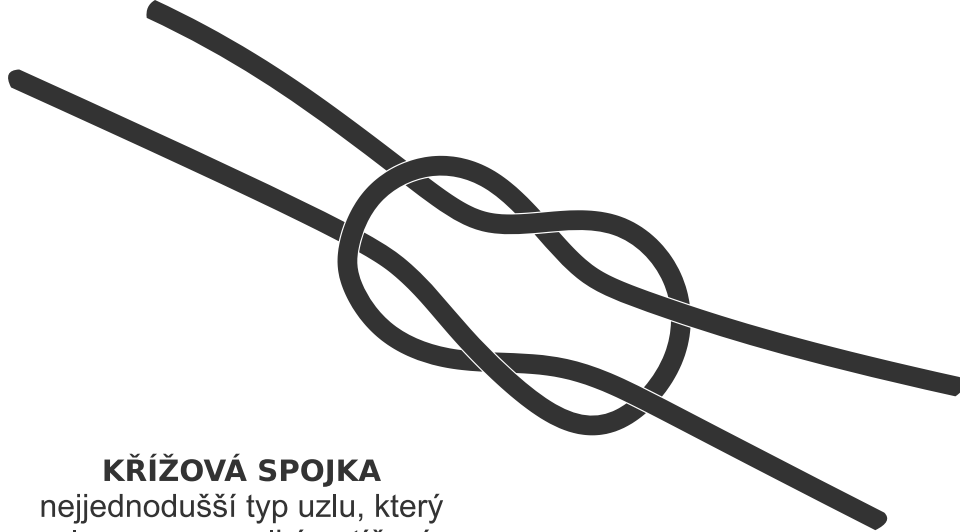

KŘÍŽOVÁ SPOJKA
nejjednodušší typ uzlu, který
ale nesnese velké zatížení



VŮDCOVSKÝ UZEL
oko, které vznikne je pevné a
nestahuje se

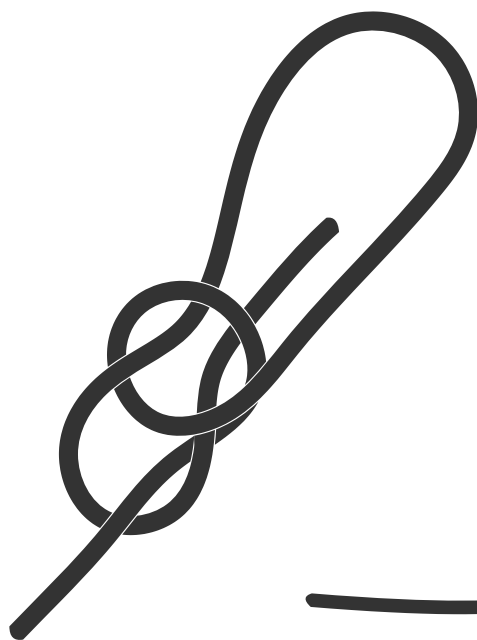

DRAČÍ SMYČKA
velmi pevný uzel, který se
dříve využíval hojně horolezci

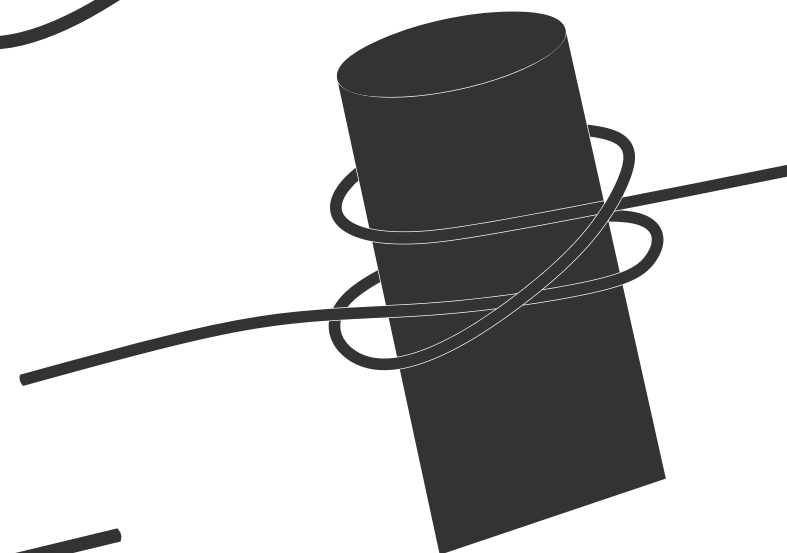

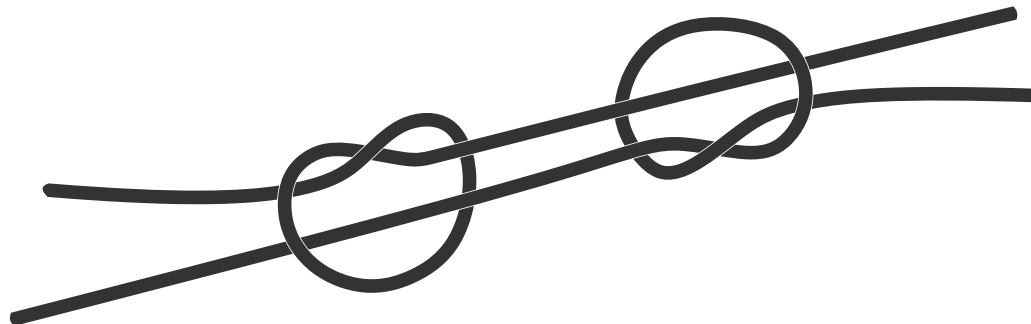

LODNÍ SMYČKA
velmi důležitý uzel, který se
jednoduše váže na kůly a je
velmi pevný

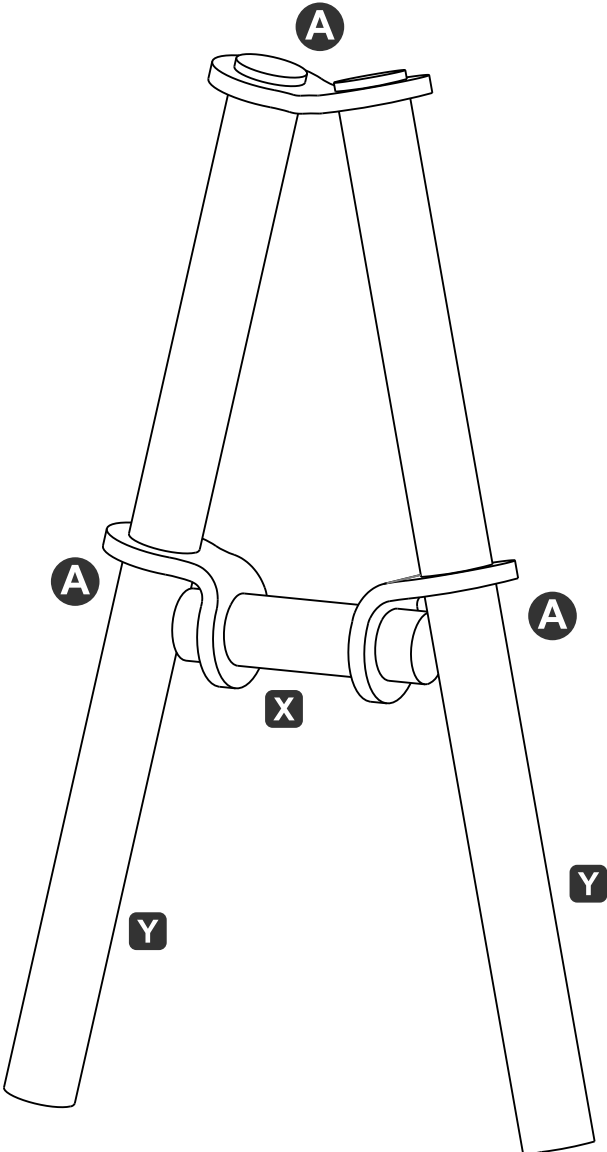

RYBÁŘSKÁ SPOJKA
slouží k pohlednému
svázání dvou provázků



-  A 3x
-  3 cm X 1x
-  12cm Y 2x

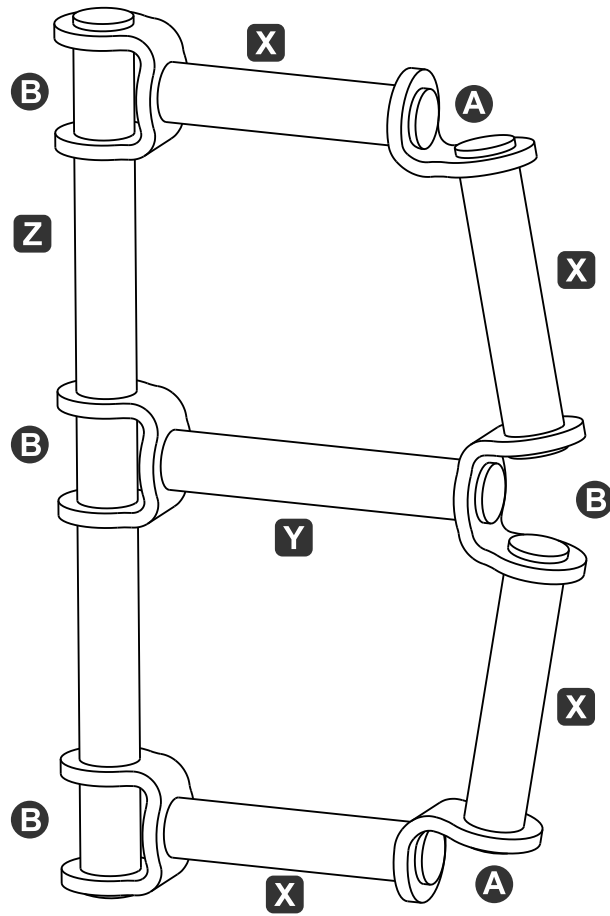

2x **A**

4x **B**

4x **X**

1x **Y**

1x **Z**

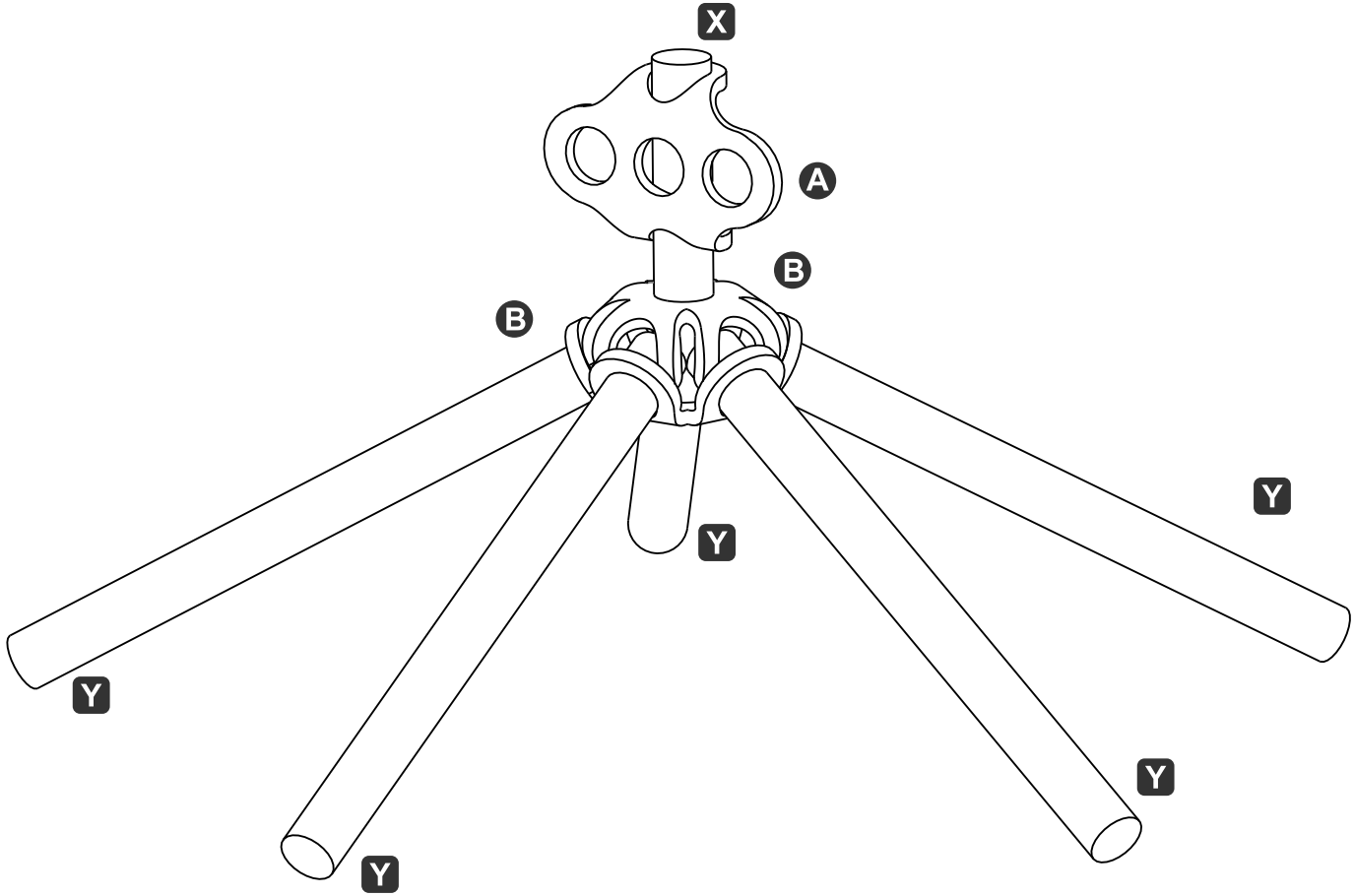

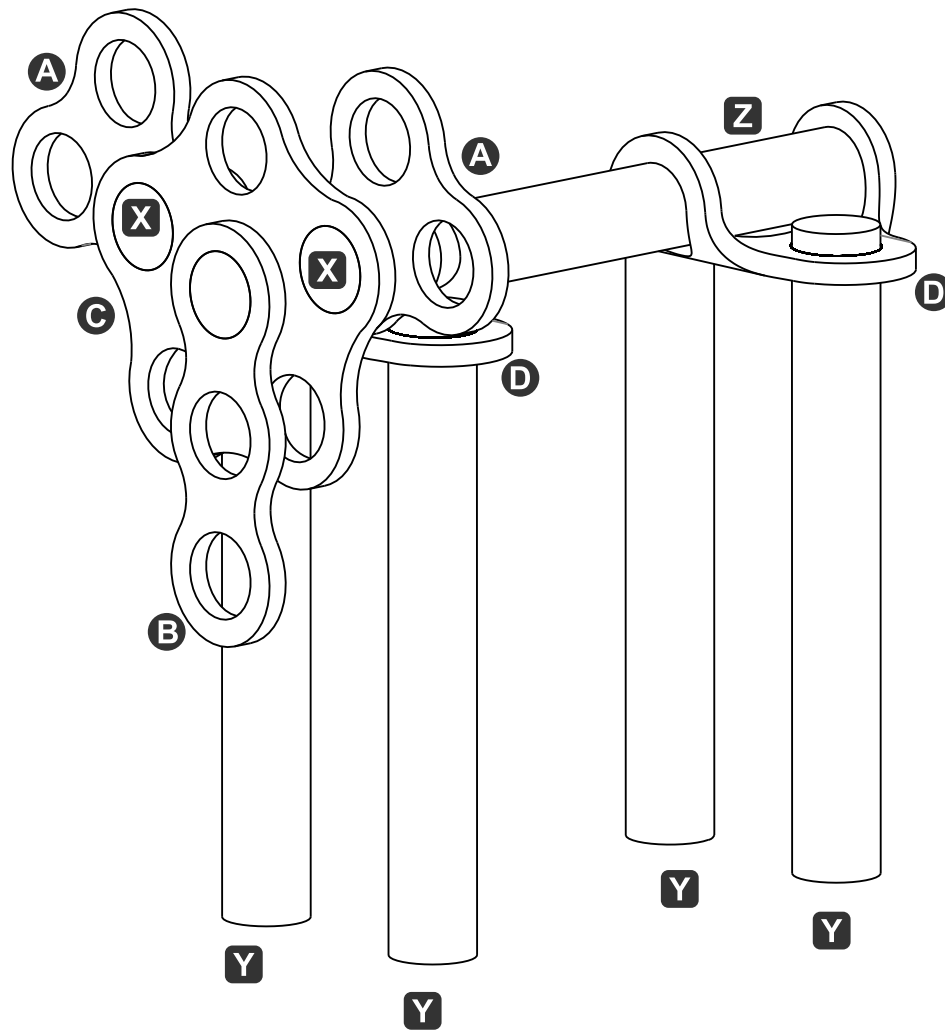





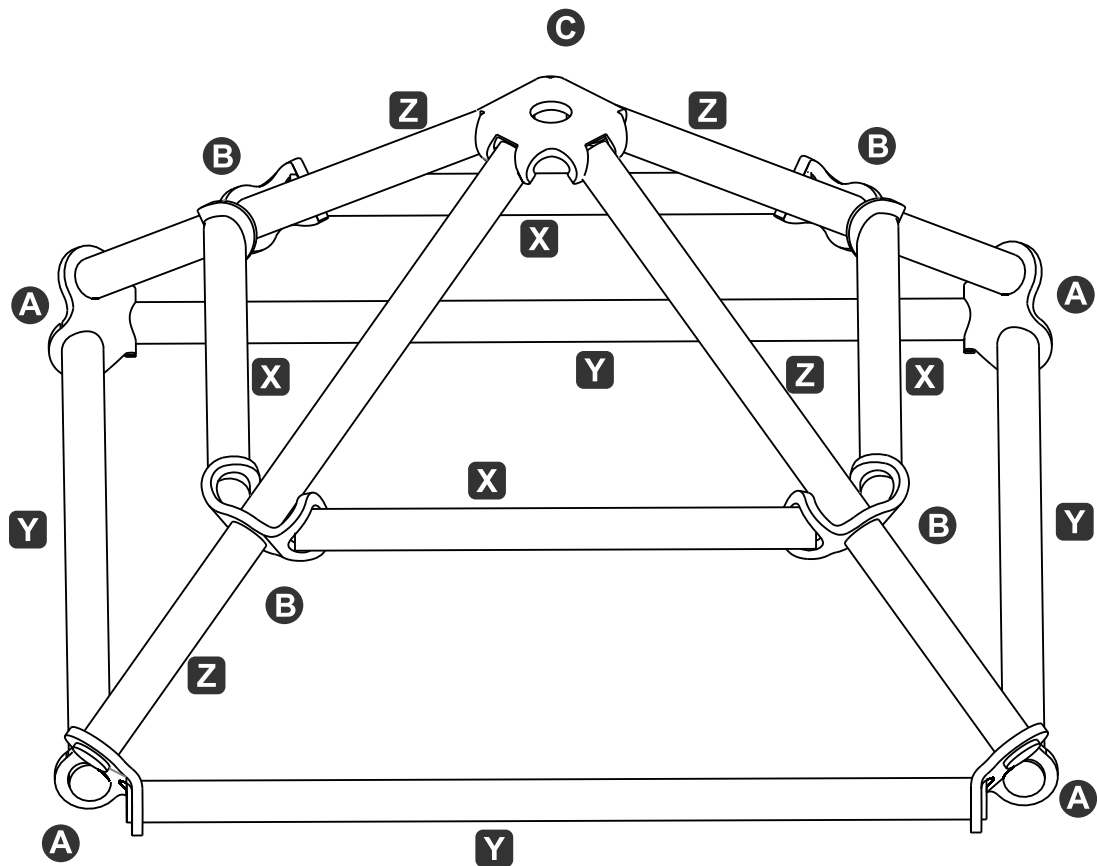

- 2x **A**
- 1x **B**
- 1x **C**
- 2x **D**

2x **X** 1cm

4x **Y** 6cm

1x **Z** 8cm



-  **A** 4x
-  **B** 4x
-  **C** 1x
-  **10cm X** 4x
-  **14,5cm Y** 4x
-  **16,5cm Z** 4x

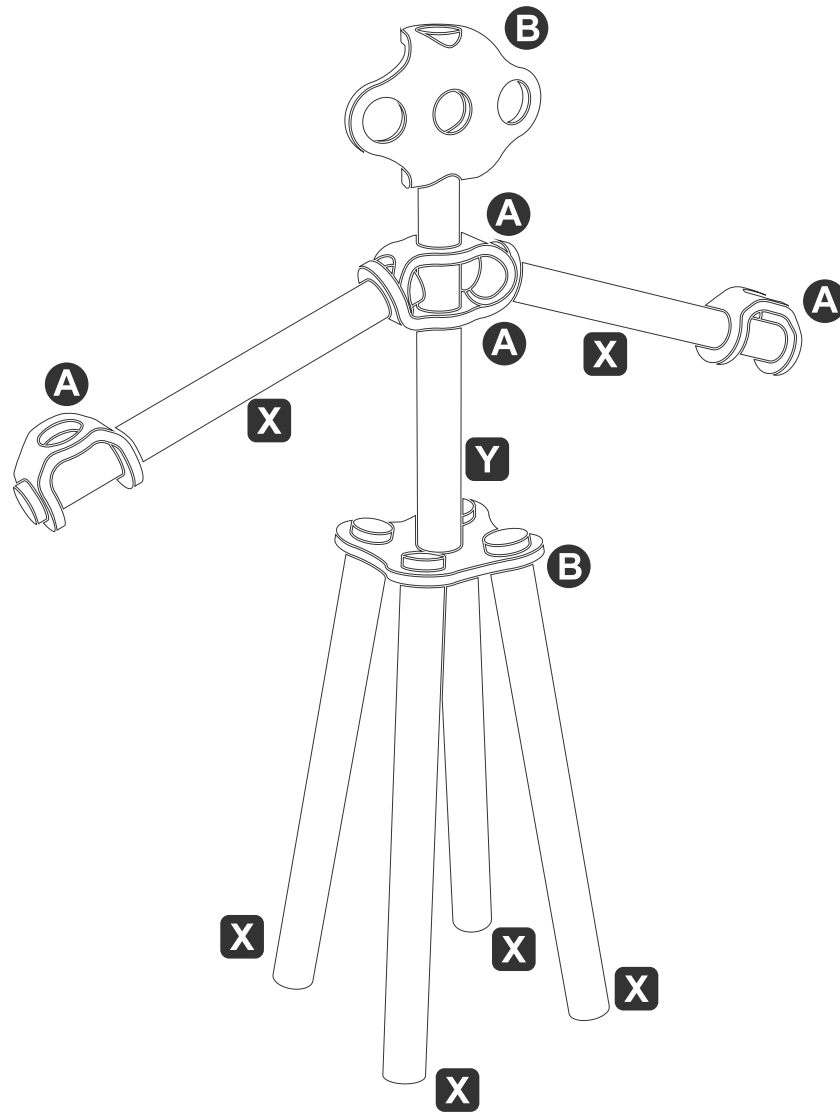





4x **A**

2x **B**

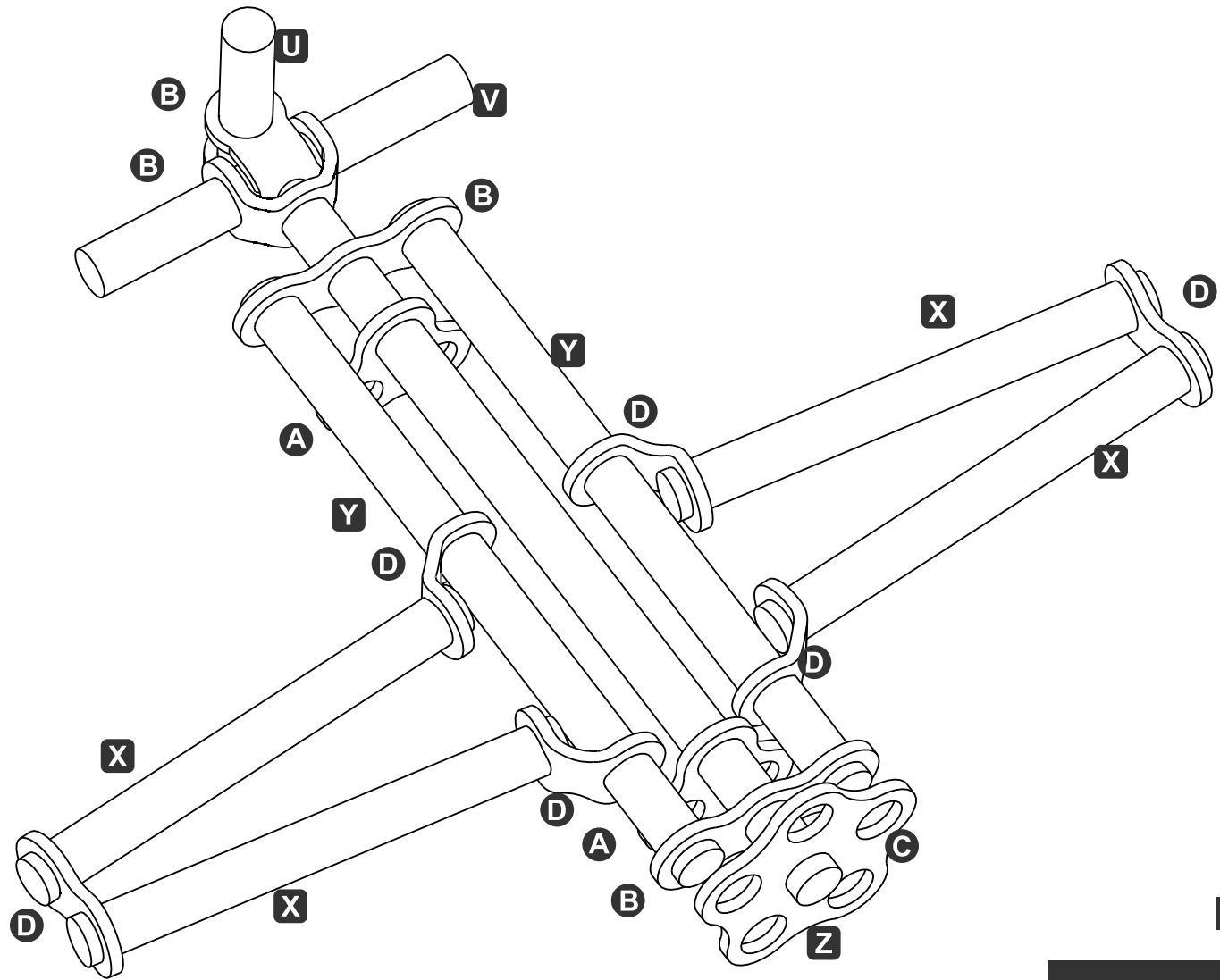
6x **X**

1x **Y**



-  **A** 2x
-  **B** 4x
-  **C** 1x
-  **D** 6x

 **4cm U** 1x

 **6,5cm V** 1x

 **8cm X** 4x

 **12cm Y** 2x

 **14cm Z** 1x

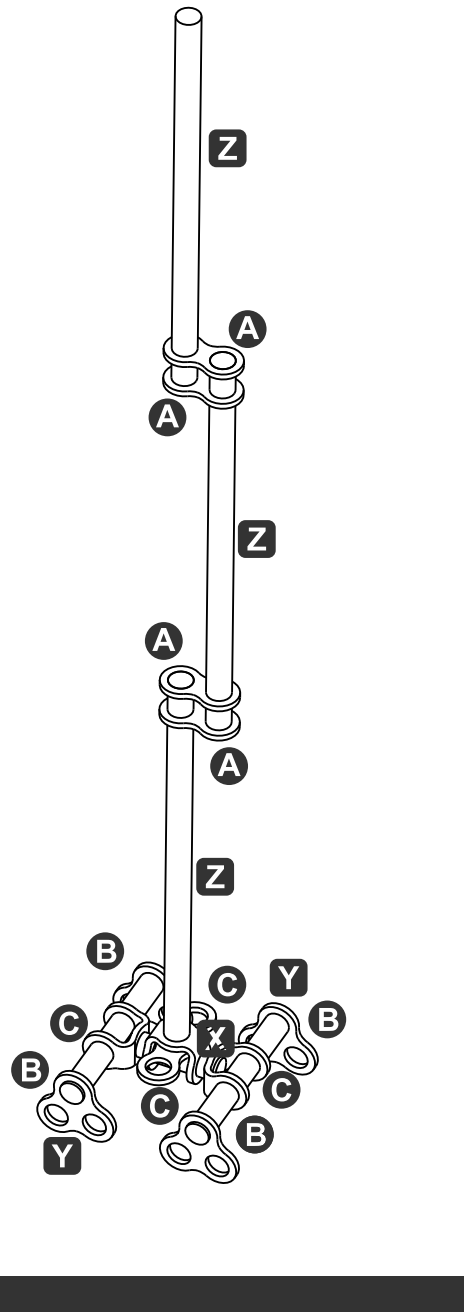

4x **A** 

4x **B** 

4x **C** 

1x **X**  3cm

2x **Y**  6cm

3x **Z**  15cm

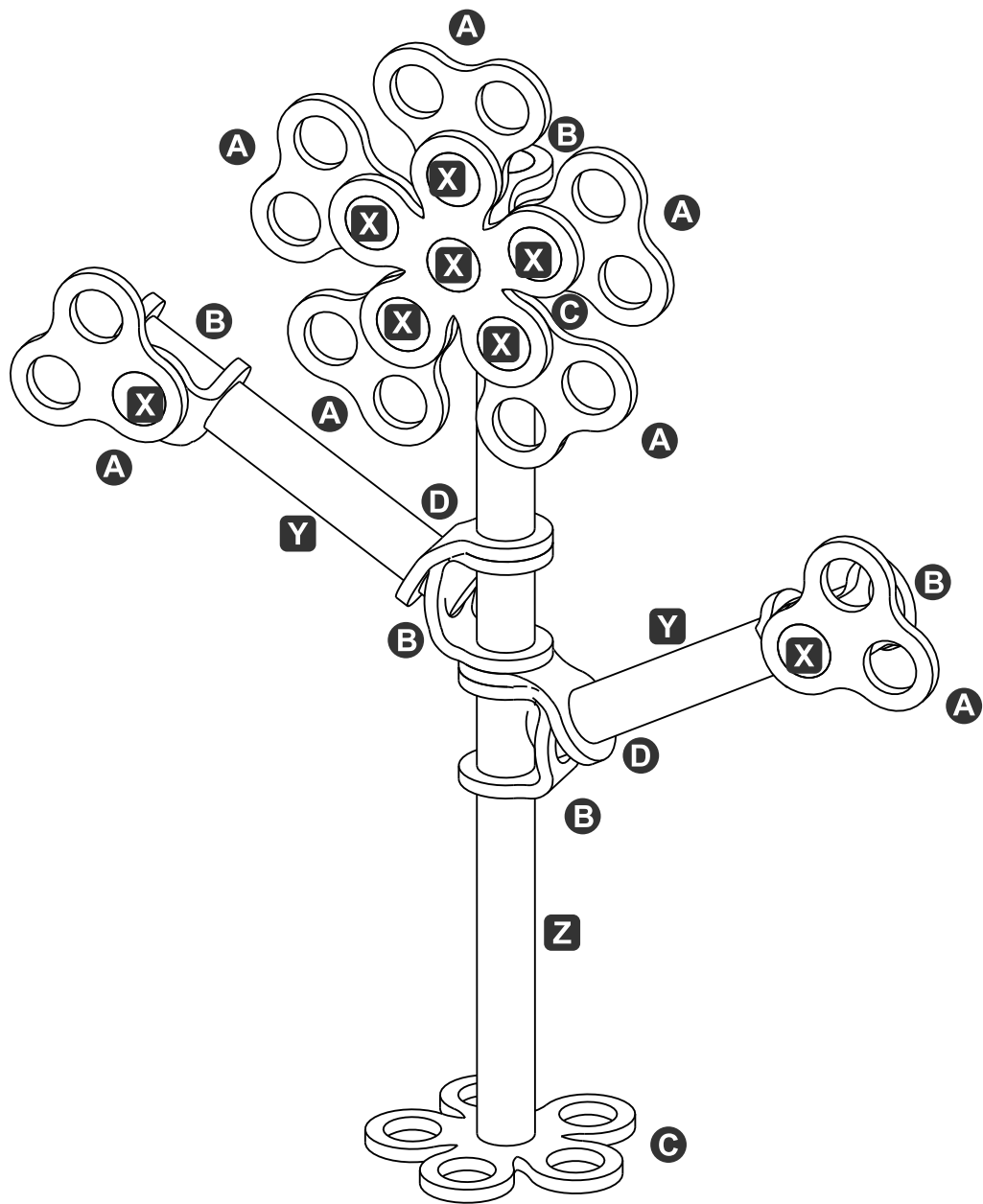

-  **A** 7x
-  **B** 5x
-  **C** 2x
-  **D** 2x
- 1cm** **X** 8x
- 6cm** **Y** 2x
- 15cm** **Z** 1x

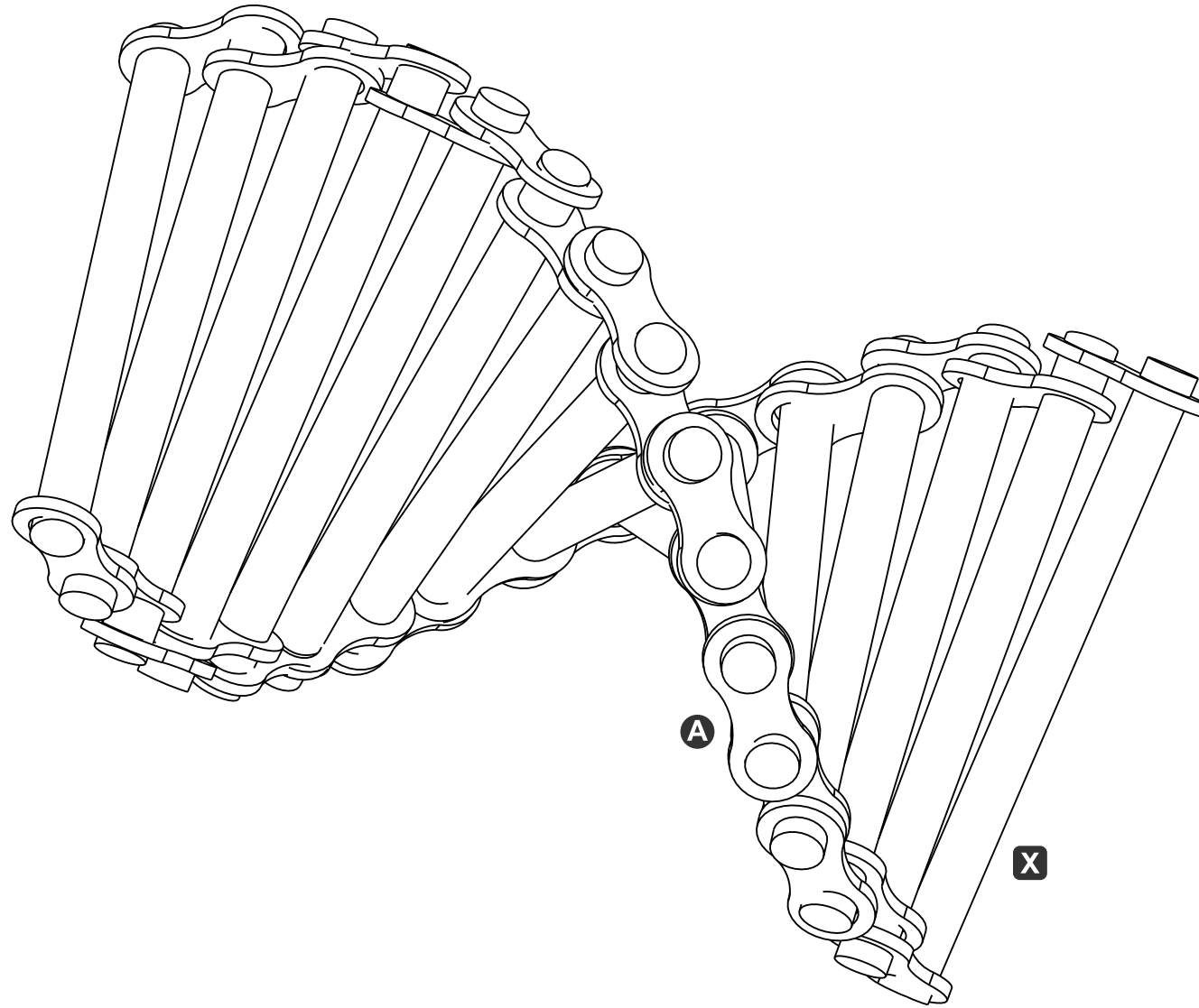

30x **A** 

16x **X**  10cm



Adresa výrobce:

IdeaHub z.s.
Technologická 373/4, Pustkovec
708 00 Ostrava
Česká republika
DIČ: CZ 05358078

info@ideahub.cz
www.ideahub.cz

